

High speed Switching Diode

FEATURES

- Extremely small surface mounting type.
- Small package.
- High speed and high reliability

APPLICATIONS

- High speed switching.

ORDERING INFORMATION

Type No.	Marking	Package Code
1SS400	A	SOD-523



MAXIMUM RATING @ Ta=25°C unless otherwise specified

Parameter	Symbol	Limits	Unit
Peak reverse voltage	V_{RM}	90	V
DC Reverse voltage	V_R	80	V
Continuous forward current	I_F	225	mA
Surge current	I_{FSM}	0.5	A
Total power dissipation	P_{tot}	150	mW
Junction temperature	T_j	125	°C
Storage temperature	T_{stg}	-55-125	°C

ELECTRICAL CHARACTERISTICS @ Ta=25°C unless otherwise specified

Parameter	Symbol	Min.	Typ.	Max.	Unit	Conditions
Forward voltage	V_F			1.2	V	$I_F=100mA$
Reverse current	I_R			20	μA	$V_R=80V$
Diode capacitance	C_d		0.72	3.0	pF	$V_R=0.5V, f=1MHz$
Reverse recovery time	t_{rr}			4	ns	$V_R=6V, I_F=10mA, R_L=100\Omega$

High speed Switching Diode

TYPICAL CHARACTERISTICS @ $T_a=25^\circ\text{C}$ unless otherwise specified

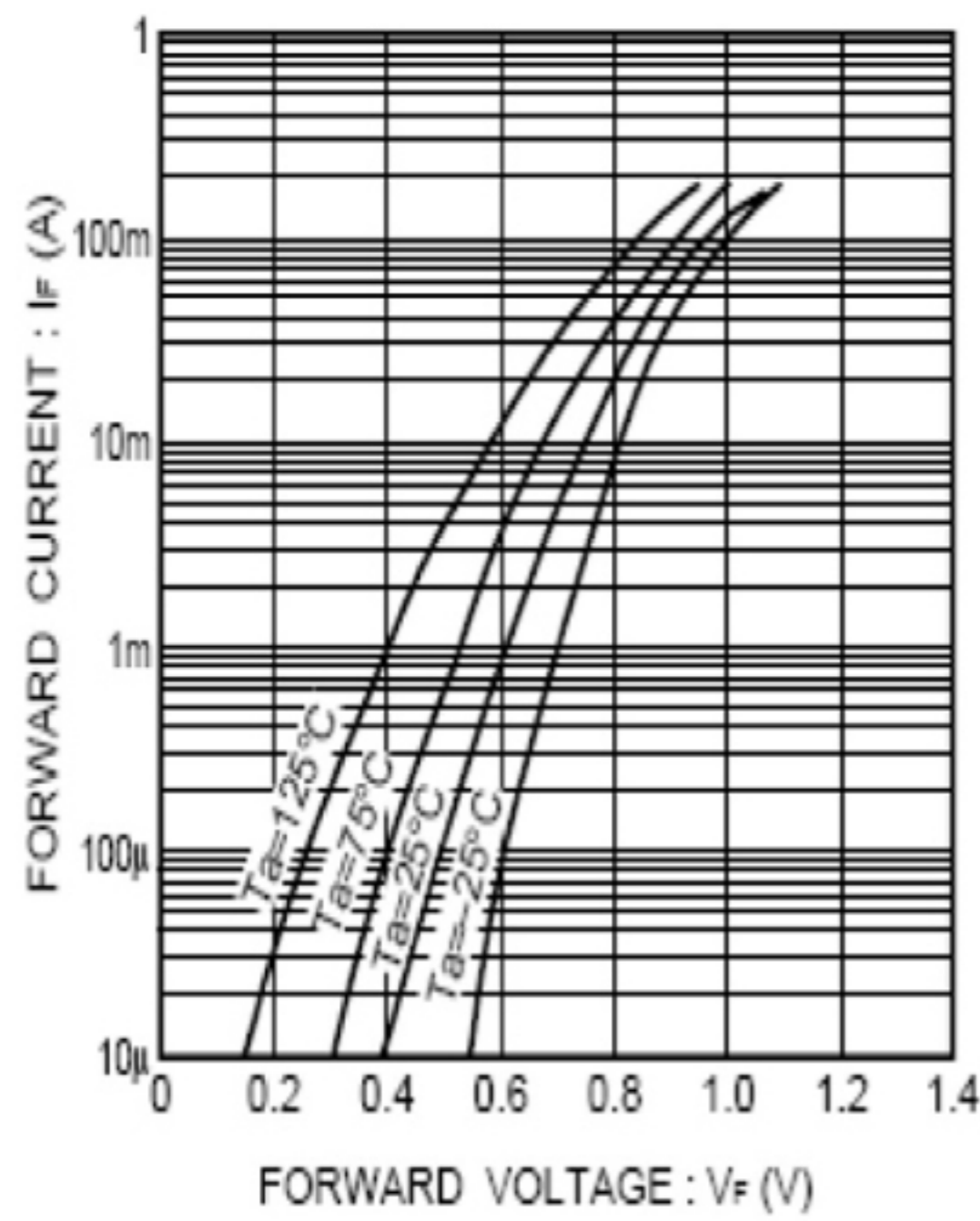

Fig.1 Forward characteristics

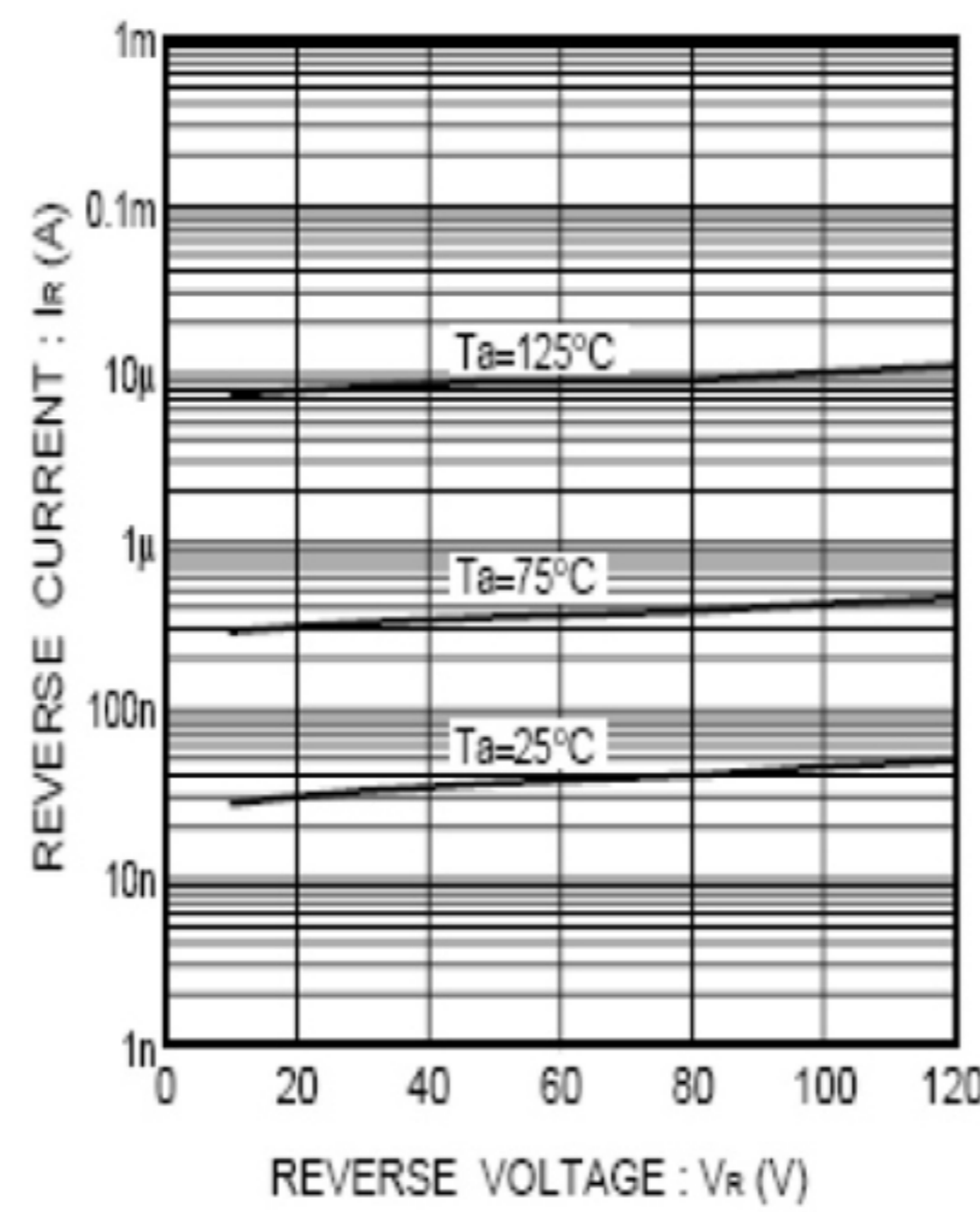

Fig.2 Reverse characteristics

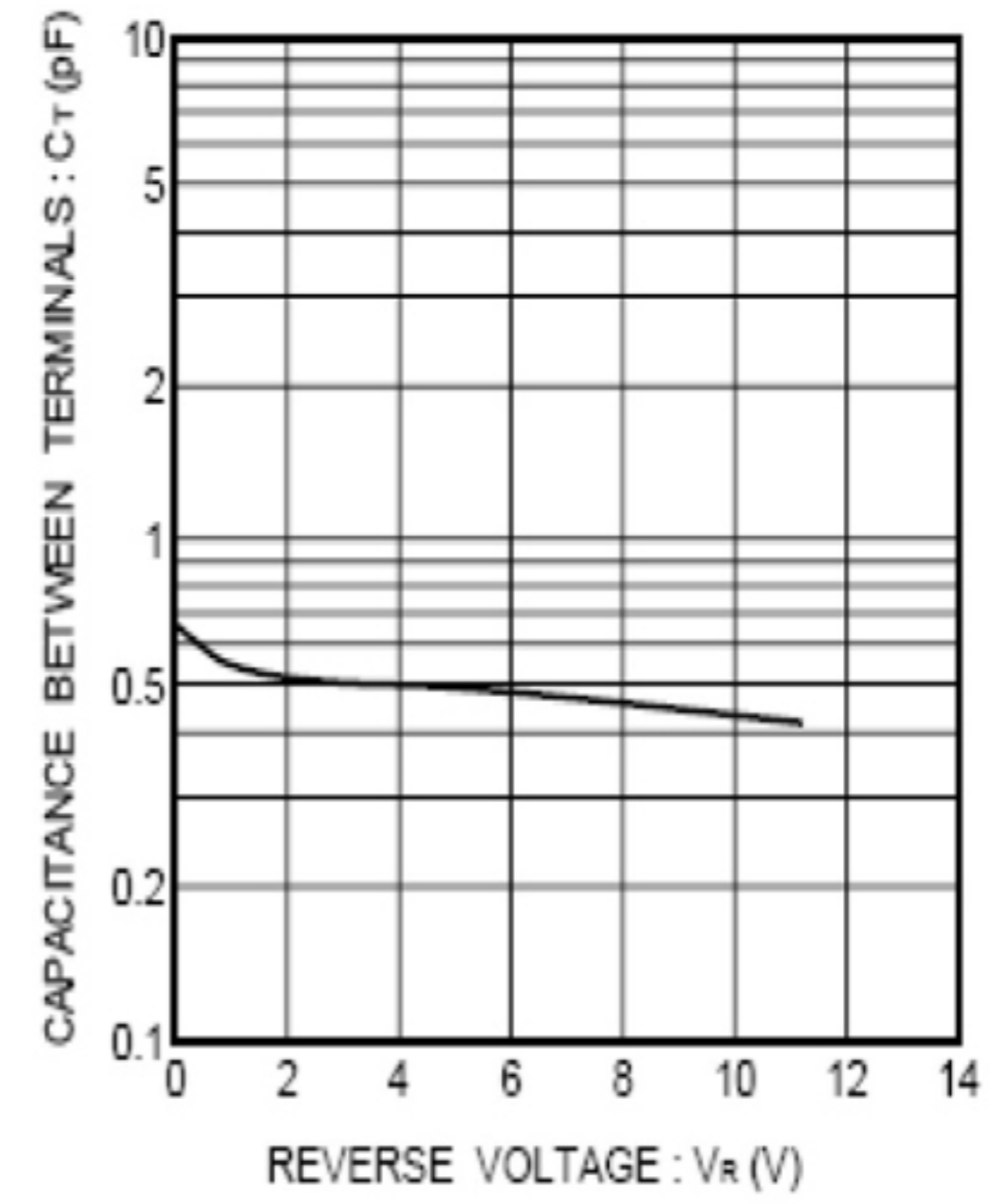

Fig.3 Capacitance between terminals

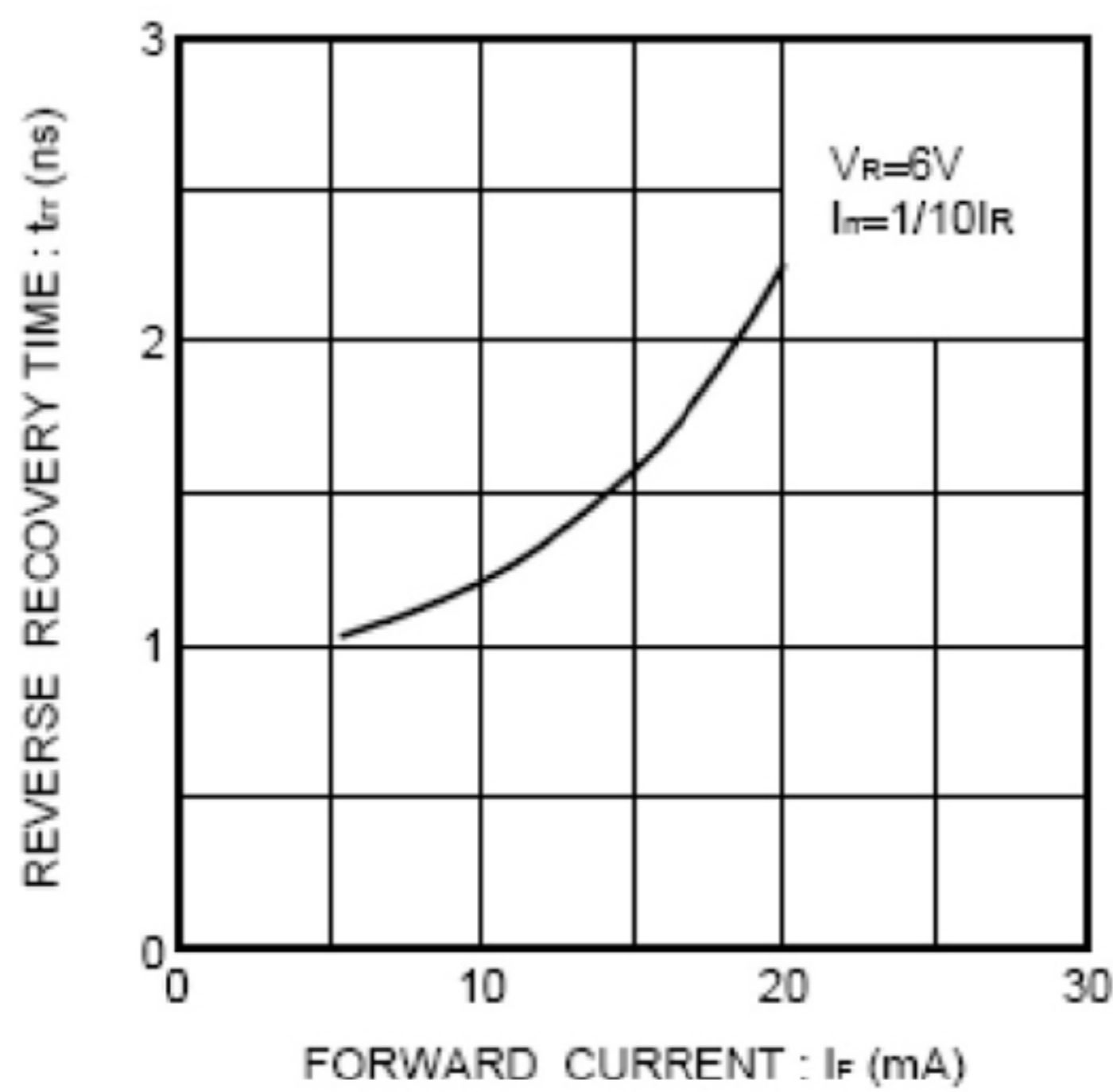

Fig.4 Reverse recovery time characteristics

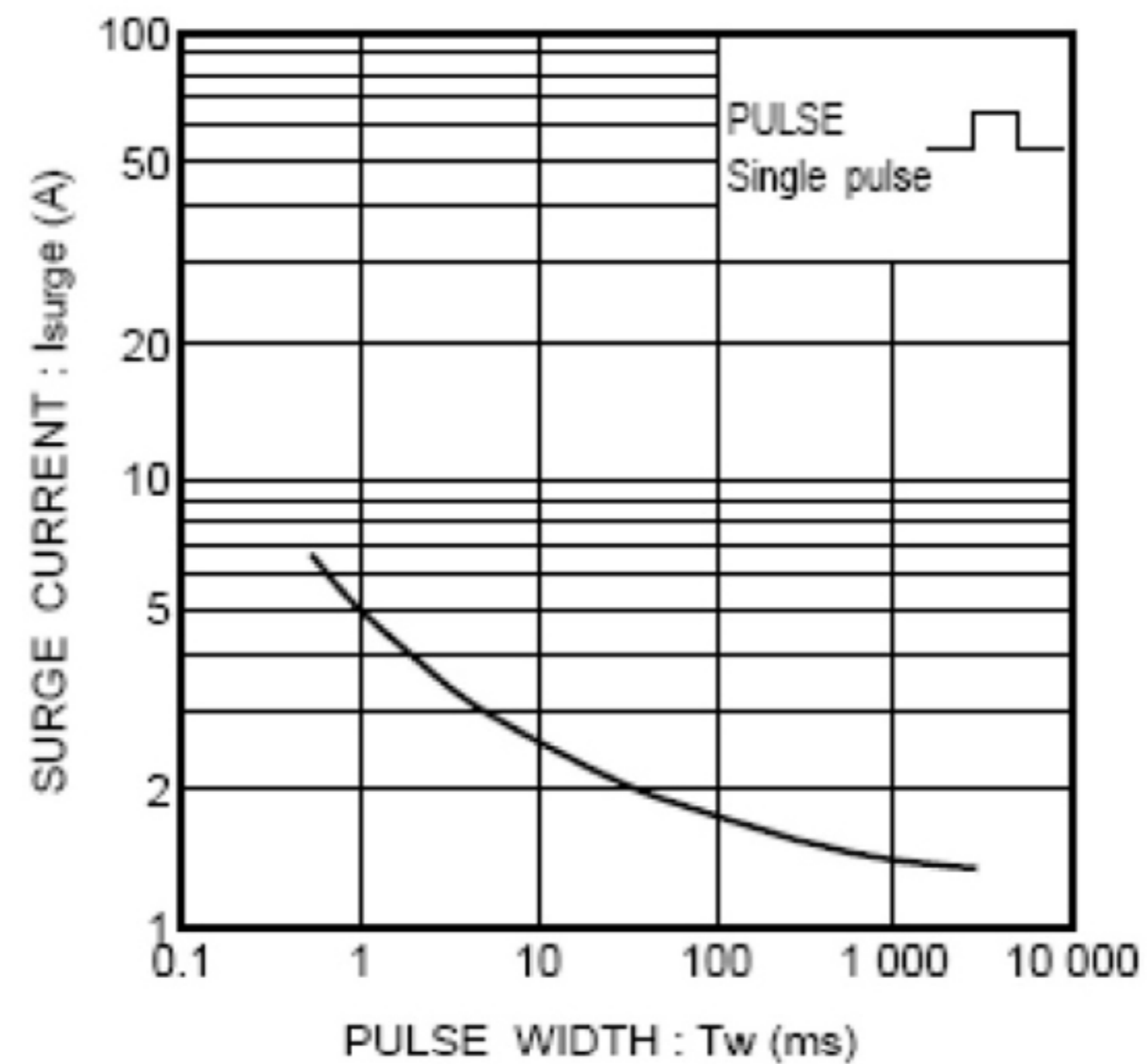

Fig.5 Surge current characteristics

High speed Switching Diode

PACKAGE OUTLINE

Plastic surface mounted package

SOD-523

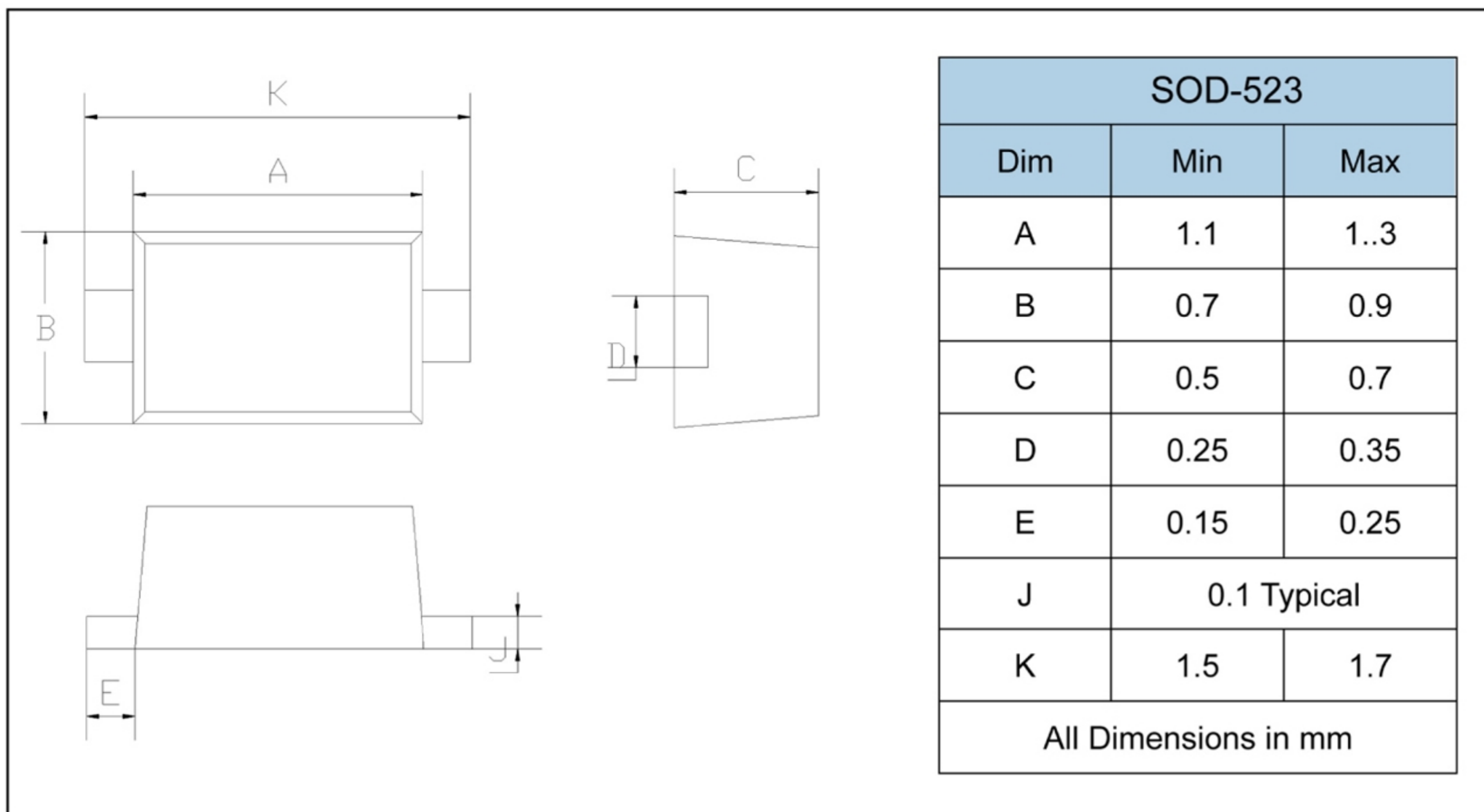

SOLDERING FOOTPRINT

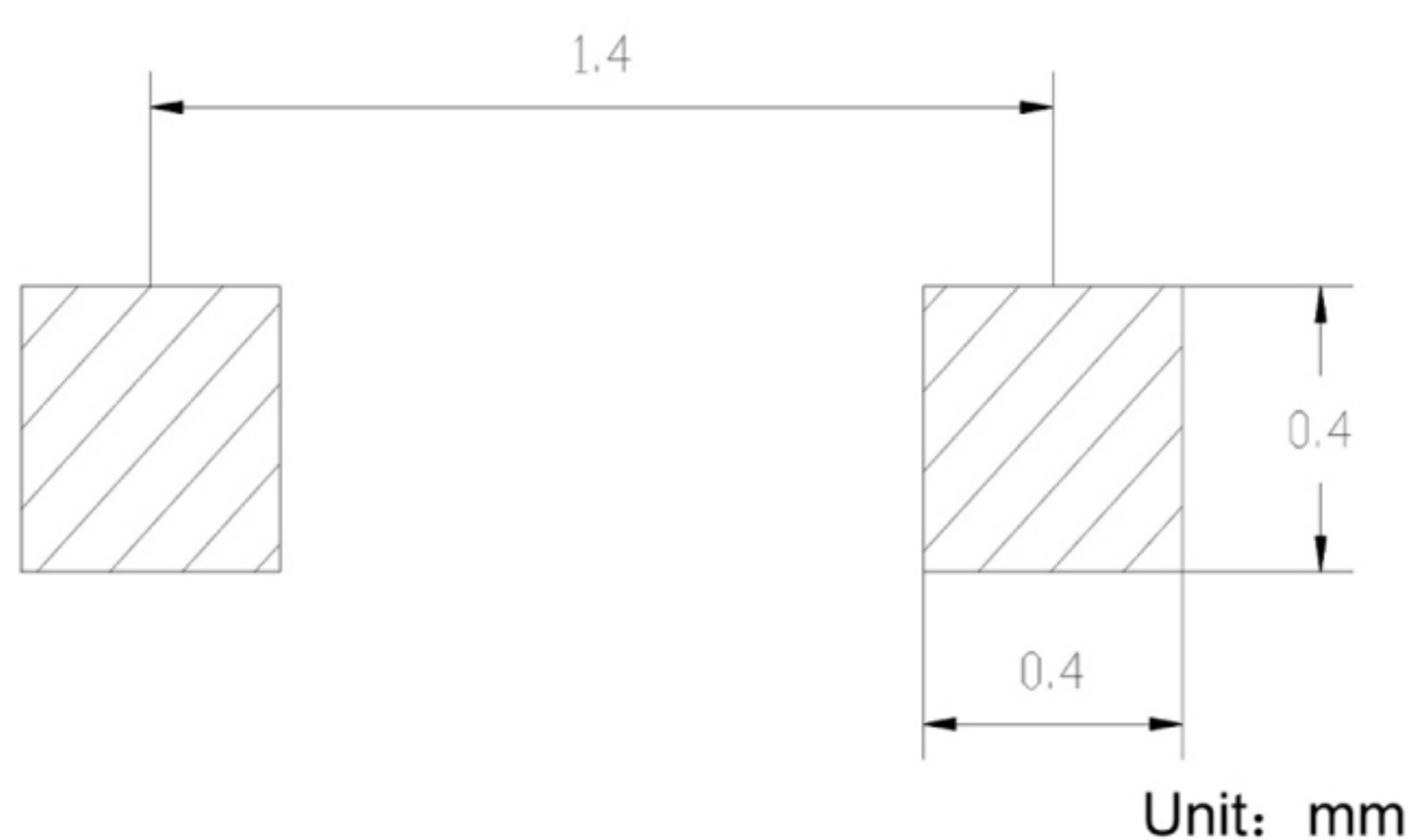

PACKAGE INFORMATION

Device	Package	Shipping
1SS400	SOD-523	3000/Tape&Reel