

Silicon Epitaxial Planar Diodes

High Voltage Switching Diode

Features

- Fast switching speed
- Surface mount package ideally suited for automatic insertion

	BAV19WS	BAV20WS	BAV21WS
MARKING	A8	T2	T3

PINNING

PIN	DESCRIPTION
1	Cathode
2	Anode

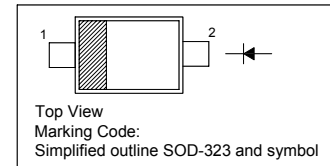

Absolute Maximum Ratings ($T_a = 25\text{ }^\circ\text{C}$)

Parameter	Symbol	Value	Unit
Repetitive Peak Reverse Voltage	BAV19WS BAV20WS BAV21WS V_{RRM}	120 200 250	V
Reverse Voltage	BAV19WS BAV20WS BAV21WS V_R	100 150 200	V
Average Rectified Forward Current	$I_{F(AV)}$	200	mA
Forward Continuous Current	I_{FM}	400	mA
Repetitive Peak Forward Current	I_{FRM}	625	mA
Non-Repetitive Peak Forward Surge Current	at $t = 1\text{ }\mu\text{s}$ at $t = 1\text{ s}$ I_{FSM}	2.5 0.5	A
Power Dissipation	P_{tot}	200	mW
Operating and Storage Temperature Range	T_j, T_{stg}	- 65 to + 150	$^\circ\text{C}$

Characteristics at $T_a = 25\text{ }^\circ\text{C}$

Parameter	Symbol	Min.	Max.	Unit
Reverse Breakdown Voltage at $I_R = 100\text{ }\mu\text{A}$	BAV19WS BAV20WS BAV21WS $V_{(BR)R}$	120 200 250	- - -	V
Reverse Current at $V_R = 100\text{ V}$ at $V_R = 150\text{ V}$ at $V_R = 200\text{ V}$	BAV19WS BAV20WS BAV21WS I_R	- - -	100 100 100	nA
Forward Voltage at $I_F = 100\text{ mA}$ at $I_F = 200\text{ mA}$	V_F	- -	1 1.25	V
Total Capacitance at $V_R = 0, f = 1\text{ MHz}$	C_T	-	5	pF
Reverse Recovery Time at $I_F = I_R = 30\text{ mA}, I_{RR} = 0.1 \times I_R, R_L = 100\text{ }\Omega$	t_{rr}	-	50	ns

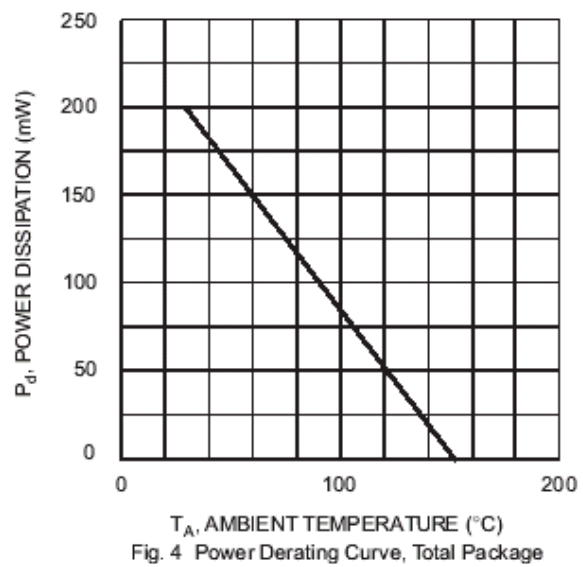
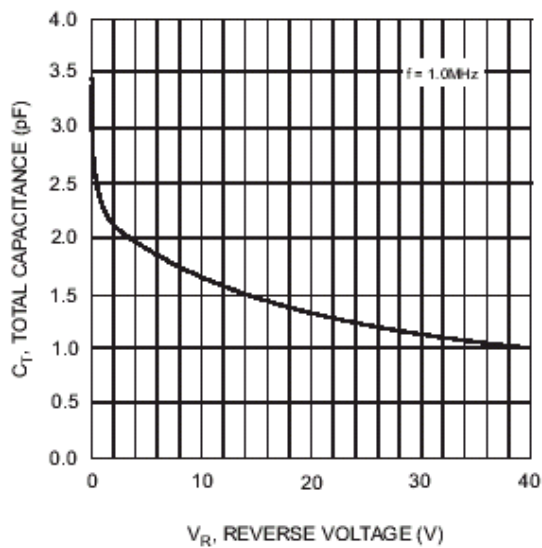
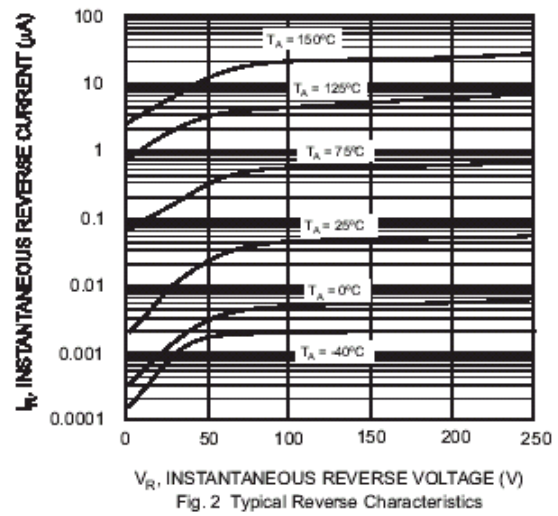
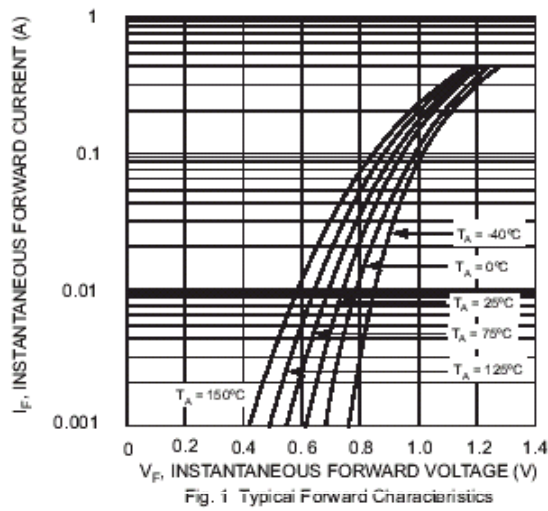

PACKAGE OUTLINE

Plastic surface mounted package;

2 leads

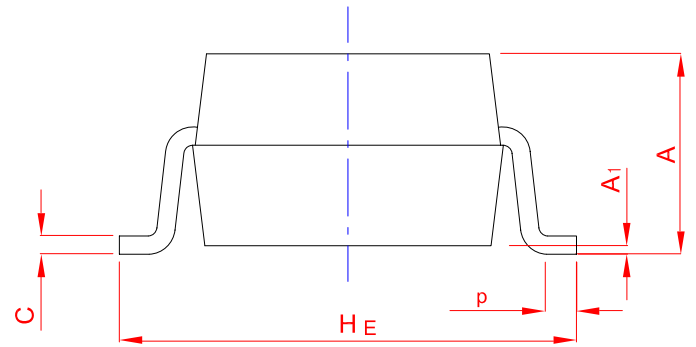
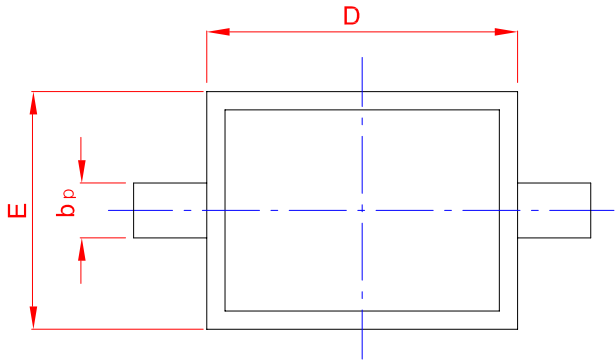

UNIT	A	bp	C	D	E	HE	A1	Lp
mm	1.20	0.40	0.15	1.80	1.35	2.80	0.10	0.50
	0.90	0.25	0.10	1.60	1.15	2.30	0.01	0.20