

Surface Mount Schottky Barrier Rectifier

Reverse Voltage - 20 and 60 V Forward Current - 1.0 A

FEATURES

- Metal silicon junction, majority carrier conduction
- For surface mounted applications
- Low power loss, high efficiency
- High forward surge current capability
- For use in low voltage, high frequency inverters, free wheeling, and polarity protection applications

MECHANICAL DATA

- Case: SMAF
- Terminals: Solderable per MIL-STD-750, Method 2026
- Approx. Weight: 27mg 0.00086oz

Absolute Maximum Ratings and Electrical characteristics

Ratings at 25°C ambient temperature unless otherwise specified. Single phase, half wave, 60Hz resistive or inductive load, for capacitive load, derate by 20 %

PINNING

PIN	DESCRIPTION
1	Cathode
2	Anode



Parameter	Symbols	SS12FL	SS14FL	SS16FL	Units
Maximum Repetitive Peak Reverse Voltage	V_{RRM}	20	40	60	V
Maximum RMS voltage	V_{RMS}	14	28	42	V
Maximum DC Blocking Voltage	V_{DC}	20	40	60	V
Maximum Average Forward Rectified Current	$I_{F(AV)}$	1.0			A
Peak Forward Surge Current, 8.3ms Single Half Sine-wave Superimposed on Rated Load (JEDEC method)	I_{FSM}	40			A
Max Instantaneous Forward Voltage at 1 A	V_F	0.45		0.50	V
Maximum DC Reverse Current at Rated DC Reverse Voltage $T_a = 25^\circ\text{C}$ $T_a = 100^\circ\text{C}$	I_R	0.3 10	0.2 5		mA
Typical Junction Capacitance ¹⁾	C_j	180		80	pF
Typical Thermal Resistance ²⁾	$R_{\theta JA}$	115			°C/W
Operating Junction Temperature Range	T_j	-55 ~ +125			°C
Storage Temperature Range	T_{sig}	-55 ~ +150			°C

1) Measured at 1MHz and applied reverse voltage of 4 V D.C. 2) P.C.B. mounted with 0.2 X 0.2" (5 X 5 mm) copper pad areas.

SS12FL THRU SS16FL

Fig.1 Forward Current Derating Curve

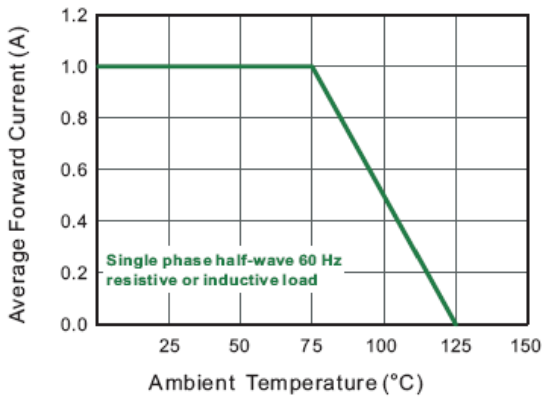

Fig.2 Typical Reverse Characteristics

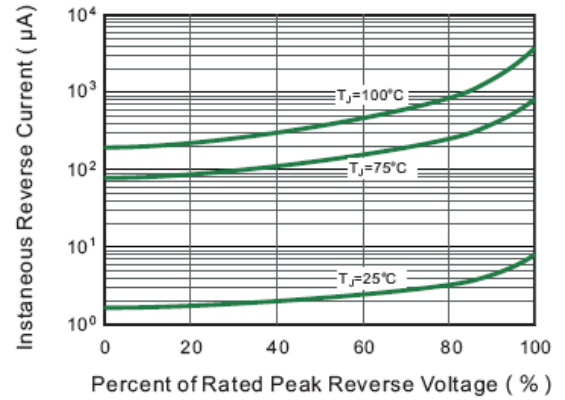

Fig.3 Typical Forward Characteristic

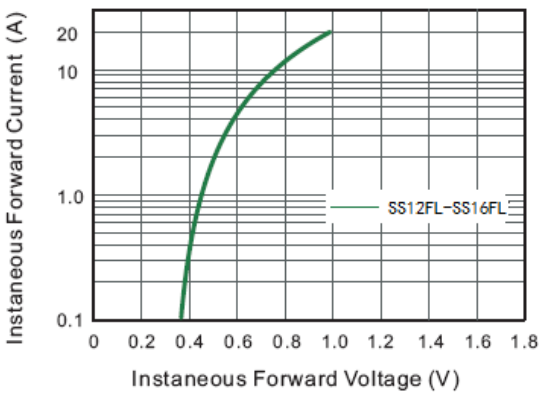

Fig.4 Typical Junction Capacitance

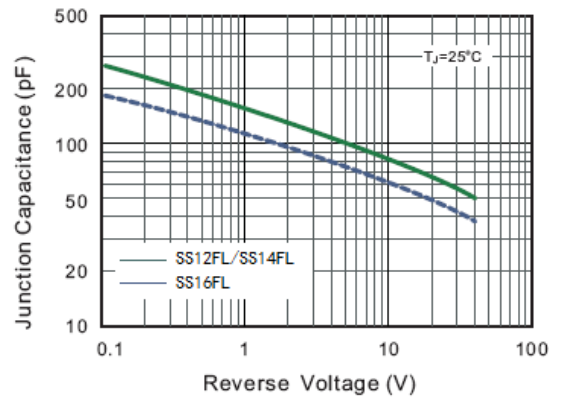

Fig.5 Maximum Non-Repetitive Peak Forward Surge Current

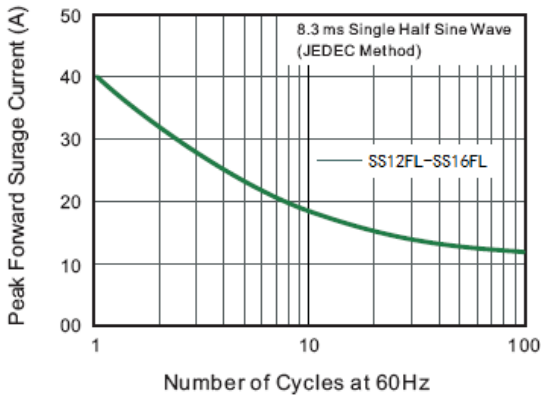
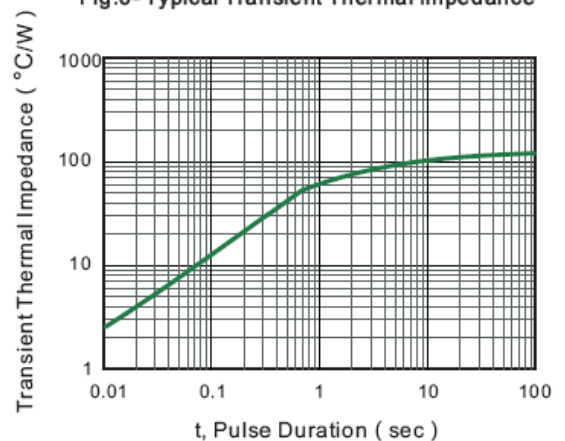

Fig.6- Typical Transient Thermal Impedance



PACKAGE OUTLINE

Plastic surface mounted package; 2 leads

SMAF

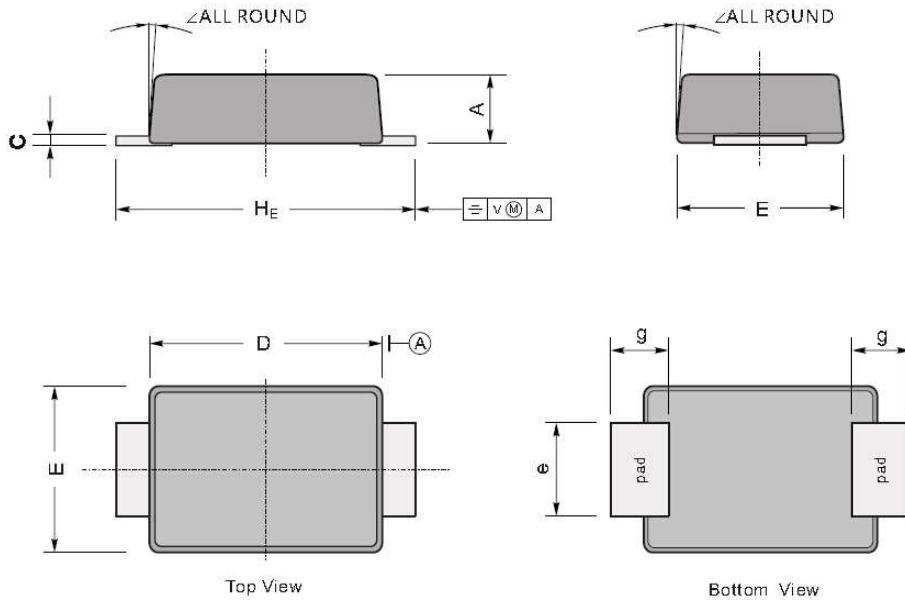

UNIT		A	C	D	E	e	g	H_E	\angle
mm	max	1.1	0.20	3.7	2.7	1.6	1.2	4.9	7°
	min	0.9	0.12	3.3	2.4	1.3	0.8	4.4	
mil	max	43	7.9	146	106	63	47	193	
	min	35	4.7	130	94	51	31	173	

The recommended mounting pad size

