

Surface Mount Schottky Barrier Rectifier
Reverse Voltage - 100 V Forward Current - 5.0A

Features

- Metal silicon junction, majority carrier conduction
- For surface mounted applications
- Low power loss, high efficiency
- High forward surge current capability
- For use in low voltage, high frequency inverters, free wheeling, and polarity protection applications

MECHANICAL DATA

- Case: SMB
- Terminals: Solderable per MIL-STD-750, Method 2026
- Approx. Weight: 0.055g / 0.002oz

PINNING

PIN	DESCRIPTION
1	Cathode
2	Anode

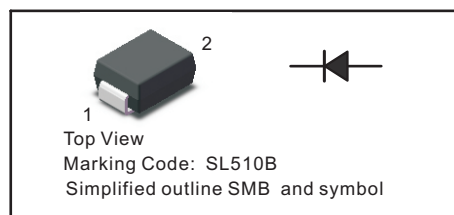

Absolute Maximum Ratings and Electrical characteristics

Ratings at 25 °C ambient temperature unless otherwise specified. Single phase, half wave, 60Hz resistive or inductive load, for capacitive load, derate by 20 %

Parameter	Symbols	SS510LBG	Units
Maximum Repetitive Peak Reverse Voltage	V_{RRM}	100	V
Maximum RMS voltage	V_{RMS}	70	V
Maximum DC Blocking Voltage	V_{DC}	100	V
Maximum Average Forward Rectified Current	$I_{F(AV)}$	5.0	A
Peak Forward Surge Current, 8.3ms Single Half Sine-wave Superimposed on Rated Load (JEDEC method)	I_{FSM}	150	A
Max Instantaneous Forward Voltage at 5 A	V_F	0.6	V
Maximum DC Reverse Current $T_a = 25^{\circ}C$ at Rated DC Reverse Voltage $T_a = 100^{\circ}C$	I_R	1.0 50	mA
Typical Junction Capacitance ⁽¹⁾	C_j	600	pF
Typical Thermal Resistance ⁽²⁾	$R_{\theta JA}$	45	$^{\circ}C/W$
Operating Junction Temperature Range	T_j	-55 ~ +150	$^{\circ}C$
Storage Temperature Range	T_{stg}	-55 ~ +150	$^{\circ}C$

(1) Measured at 1 MHz and applied reverse voltage of 4 V D.C

(2) P.C.B. mounted with 2.0" X 2.0" (5 X 5 cm) copper pad areas.

Fig.1 Forward Current Derating Curve

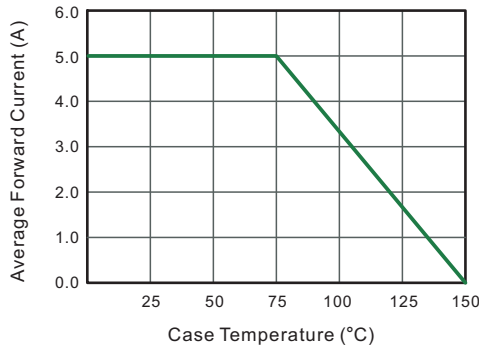

Fig.2 Typical Reverse Characteristics

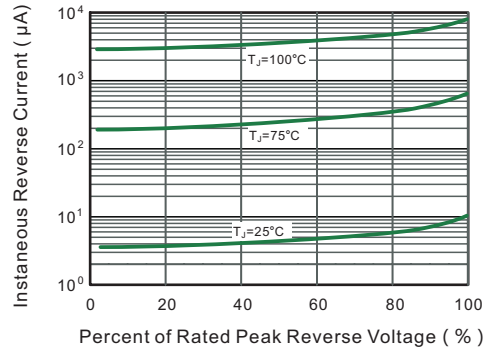

Fig.3 Typical Forward Characteristic

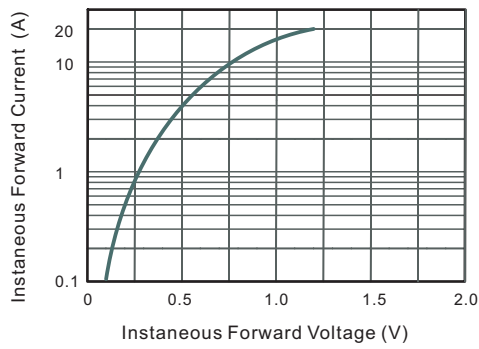

Fig.4 Typical Junction Capacitance

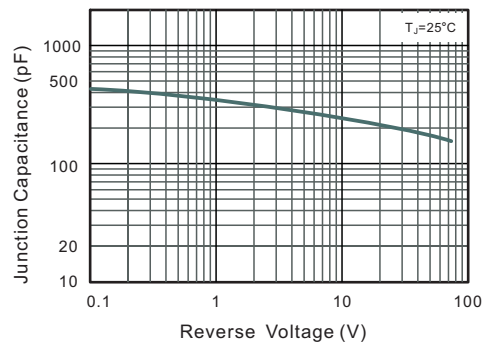

Fig.5 Maximum Non-Repetitive Peak Forward Surge Current

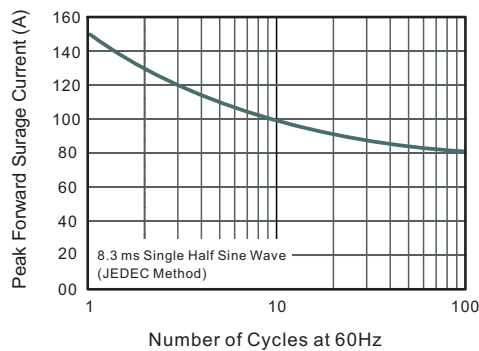
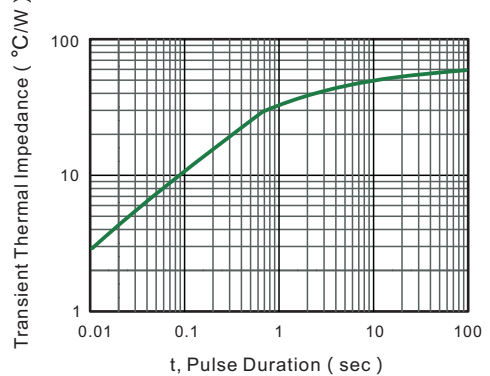

Fig.6- Typical Transient Thermal Impedance



PACKAGE OUTLINE

Plastic surface mounted package; 2 leads

SMB

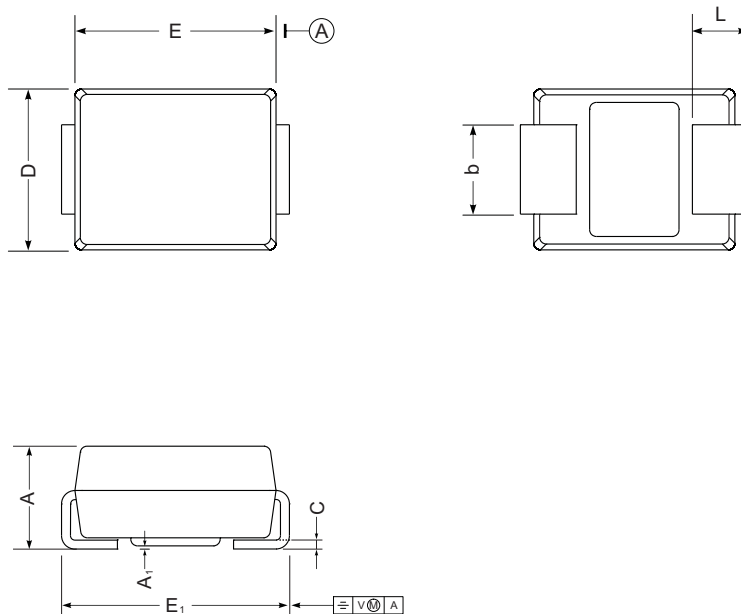

SMB mechanical data

UNIT		A	E	D	E ₁	A ₁	L	C	b
mm	max	2.44	4.70	3.94	5.59	0.20	1.5	0.305	2.2
	min	2.13	4.06	3.3	5.08	0.05	0.8	0.152	1.9
mil	max	96	185	155	220	7.9	59	12	87
	min	84	160	130	200	2.0	32	6	75

The recommended mounting pad size

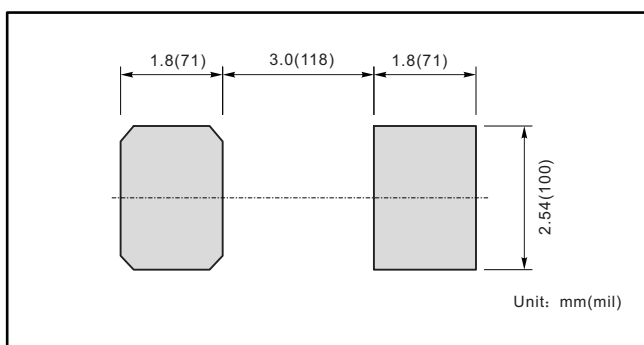

Marking

Type number	Marking code
SS 510LBG	SL510B